

What's New

"Power-to-Design circuits"

The screenshot displays the HyDraw CAD800 software interface. The main window shows a hydraulic circuit diagram with various components like pumps, valves, and hoses. To the left is the 'Component Library' with a tree view of hydraulic symbols. To the right is the 'HyDraw Property Manager' showing detailed specifications for a selected component.

ITEM ID	QTY	MODEL CODE	DESCRIPTION	MANUFACTURER
1	1	T-30P	RESERVOIR	YESCOR
2	1	EM15-18024T10TFC	ELECTRIC MOTOR	BALDOR
4	1	1P-18-000	MOTOR FLUSH ADAPTER	MAGNAFLOW
5	1	MANIFOLD-6x8	MANIFOLD	MAGNAFLOW
8	1	PG20-040R-RE-1501-C21-12	2-WAY PRESSURE COMPENSATED	EATON
8	1	020-000-01-15	2-WAY VALVE	HYDRAFORCE
9	1	P25-100	SOLENOID	FLUN ACI
11	2	DP1-05-1"	PISTON VALVE	SALESIAN FORCE
12	1	1 1/2 J24-10-11-11-11-11	CYLINDER	PAINTER
13	1	4WE55EE10Z11NK4	DIRECTIONAL CONTROL VALVE	BOBOH KROHNE
14	1	50A100-000-00000	FILTER	PAINTER
16	1	NP010N	NEEDLE VALVE	SUN HYDRALICS
17	1	LS-107	LEVEL & TEMP SWITCH	CEMS
18	1	MBR020	FILTER/BREATHER	EATON

HOSE ID	QTY	MODEL CODE	DESCRIPTION
H1	1	721-16	HOSE
H2	1	721-12-26	HOSE
H3	2	721-12-48	HOSE

ITEM ID	PORT TYPE	PORT SIZE	ITEM ID	DESIGN NOTE
A, B, P	SAE O-RING	#12 SAE	1	PROVIDE EXTRA WRENCH CLEARANCE
GA, GB	SAE O-RING	#14 SAE		
T	SAE O-RING	#16 SAE	13	MINIMIZE PRESSURE DROP TO TANK PORT (T)

Navigate through symbol library.



HyDraw® *"Power-to-Design"* circuits

Restructured Ribbon Menu

Custom External Ports

Design Notes: Show/Hide and Note List

Pump-Motor Adaptor Selection

Gauge Port: Configure and Insert

Select from Linked Accessories

Hoses : Hose ID and Hose List

Component as Accessory

ERP Interface

Net Pressure

Restructured HyDraw Options

New Hose ID Numbering Scheme

Search by Part Number

Migrate Settings

Import & Export Settings

HyDraw Library Manager 2015

ERP Interface Manager

Component as Accessory

Restructured Ribbon Menu

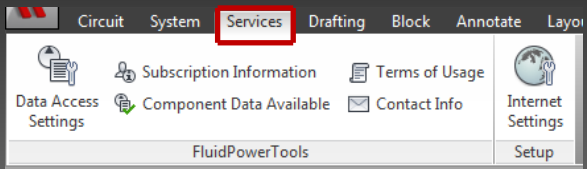
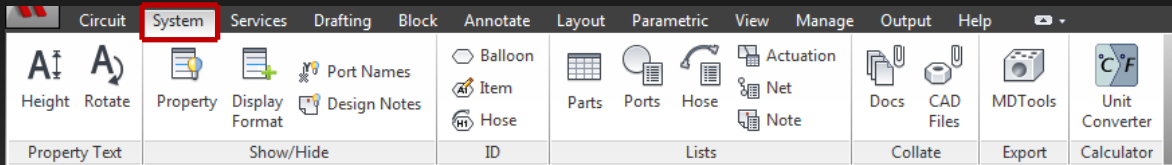
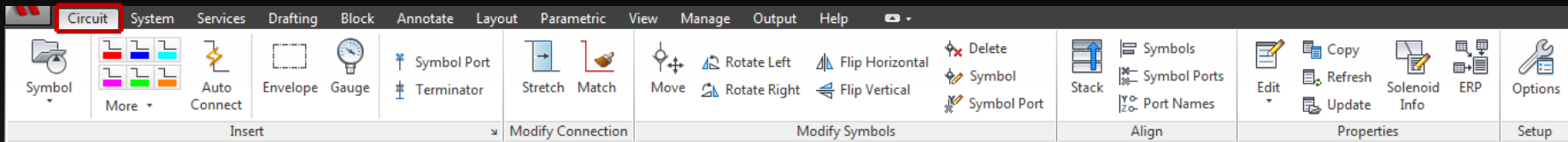

Menu restructured:
Circuit, System and Services tabs

Custom External Ports

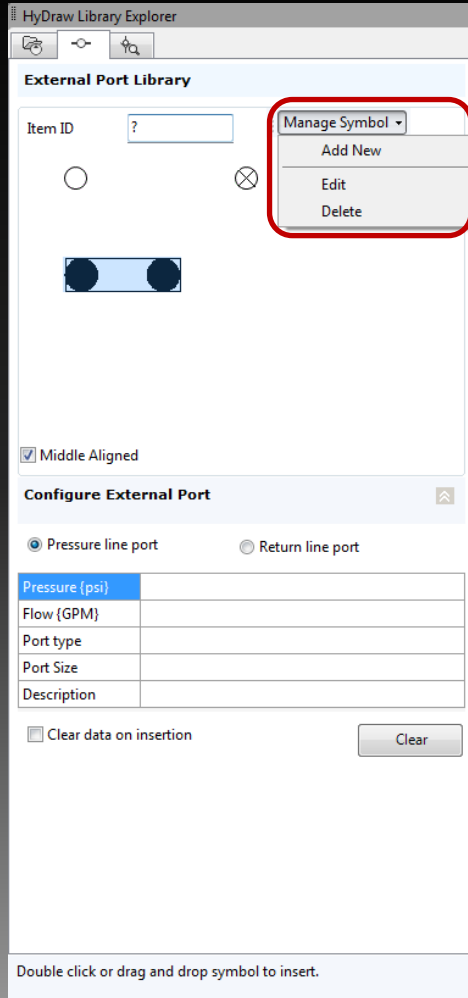

Create/Edit Custom External Ports in the **External Port Library**

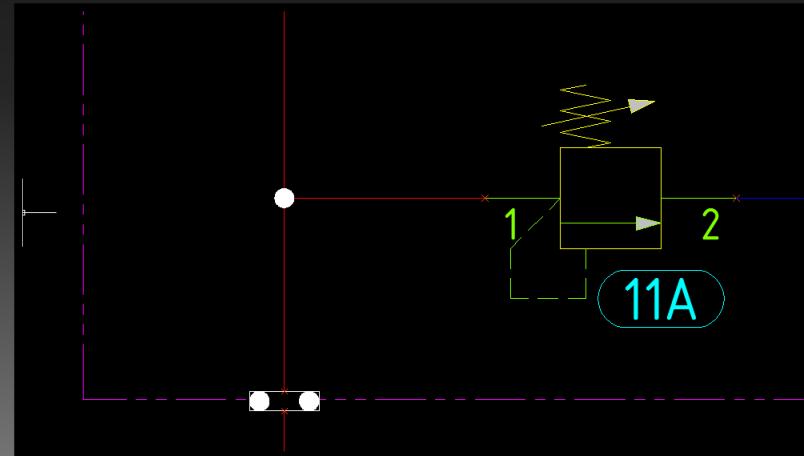

Design Notes: Show/Hide and Note List

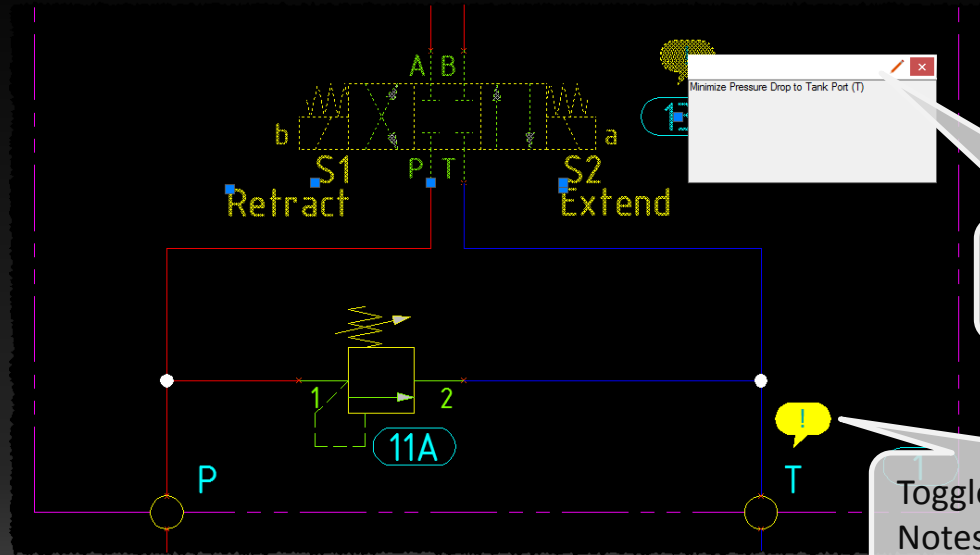
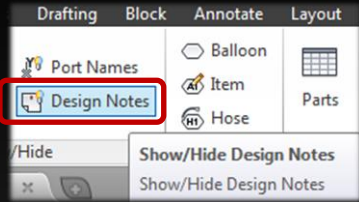

Edit Design Notes:
Double click the icon

Toggle the display of Design Notes in the drawing

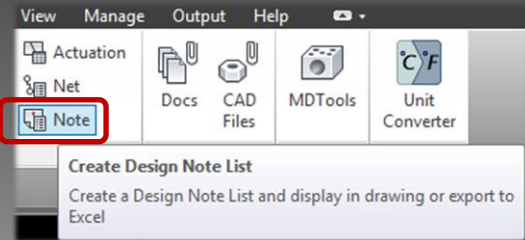

ITEM ID	DESIGN NOTE
T	PROVIDE EXTRA WRENCH CLEARANCE
13	MINIMIZE PRESSURE DROP TO TANK PORT (T)

Create a Design Note list

Pump Motor Adaptor Selection

Select Pump/Motor Adaptor

Motor	Pump	
Frame Size	Mount	
254TC	SAE B 2 bolt	
Shaft Length	Shaft Length	Minimum face to face Length
4	2.31	6.31

Available Adaptors

Model code	Manufacturer	Face to Face Length	Catalog Number	Cost	List Price
M182682B	MAGNALOY	6.81			
M182702B	MAGNALOY	7			

OK Cancel

Select Pump/Motor Adaptor based on Pump and Motor properties

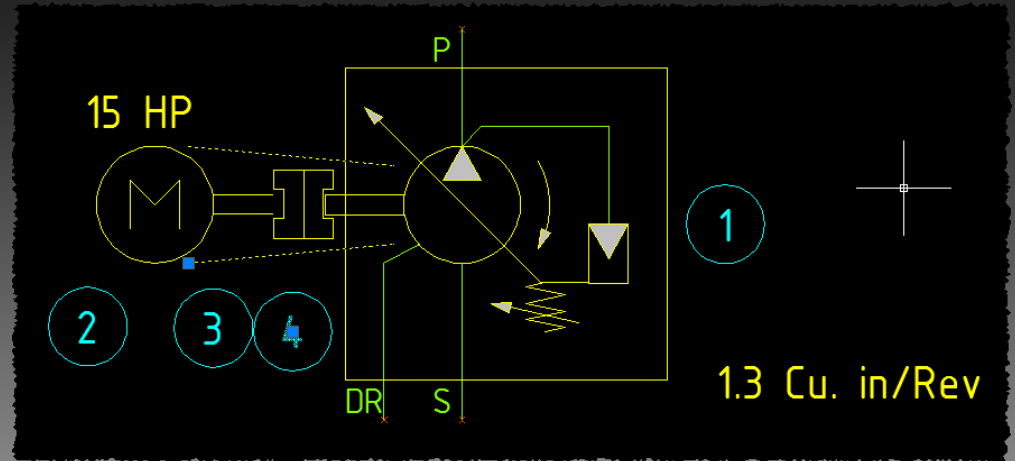

Configure and Insert Gauge Port

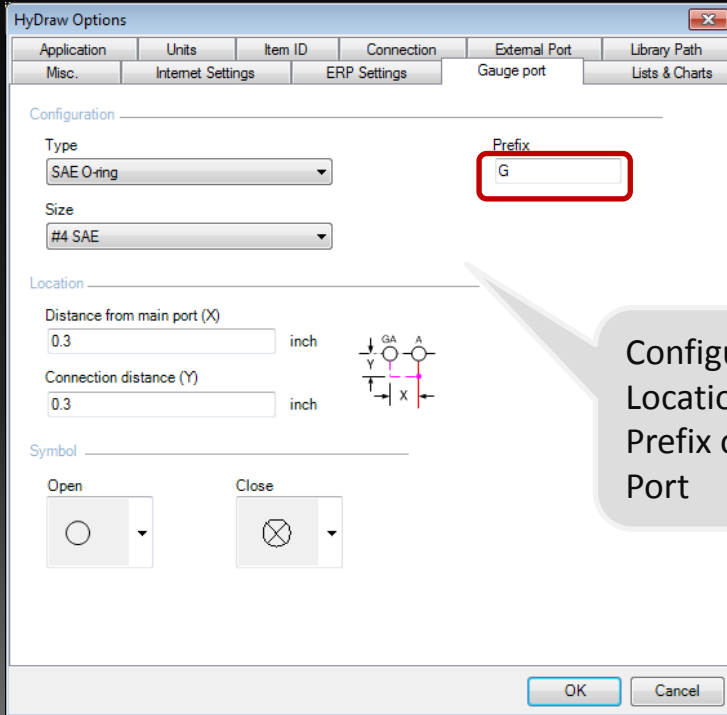

Insert a Gauge port automatically to an existing external port

Configure the Type, Location, Symbol and Prefix of the Gauge Port

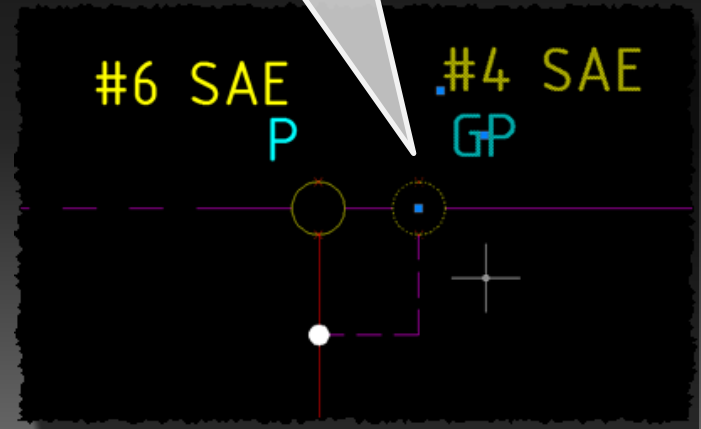

Select from Linked Accessories

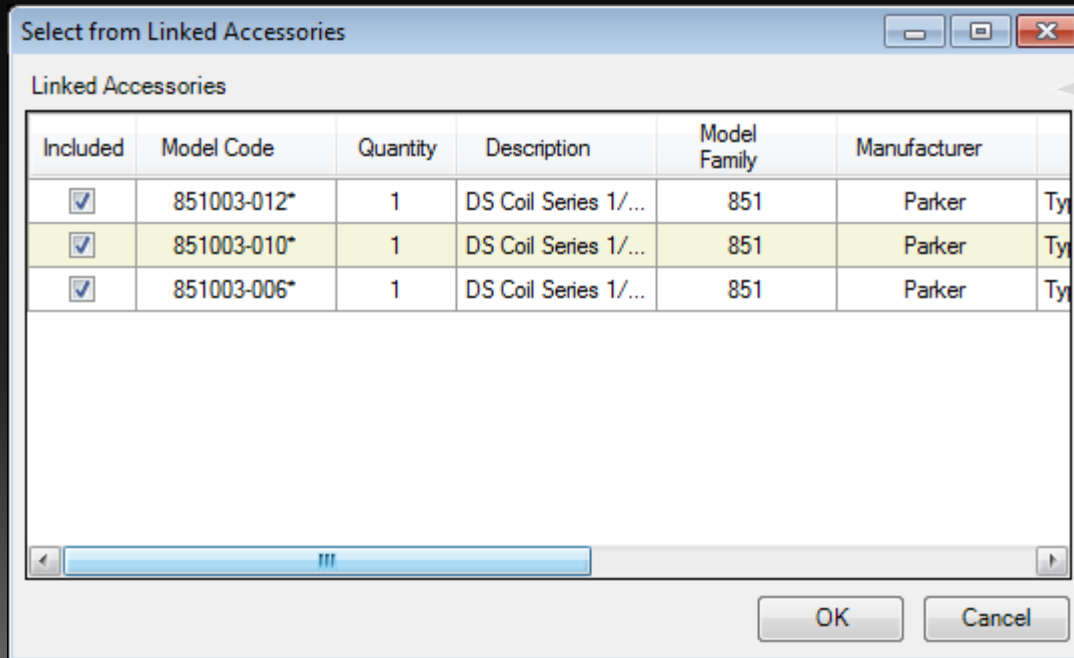

Select data from Linked Accessories when inserting symbol from HyDraw Library Explorer
or
Select data from library in the HyDraw Property Manager

Hoses: Hose ID and Hose List

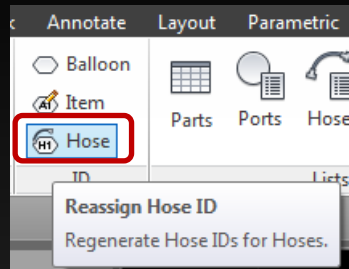

Reassign Hose ID for hoses in the drawing

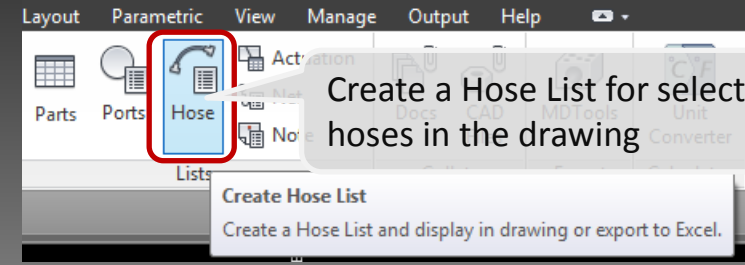
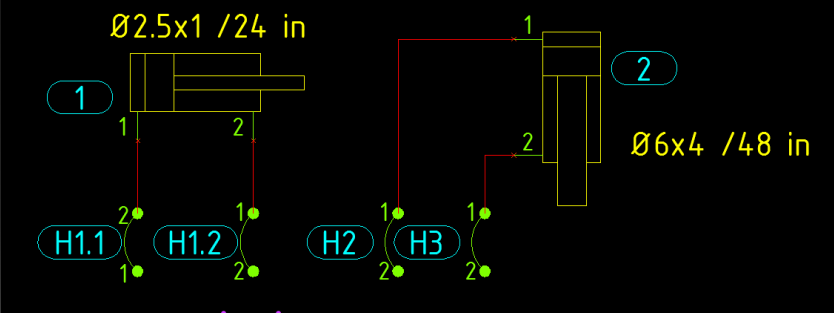
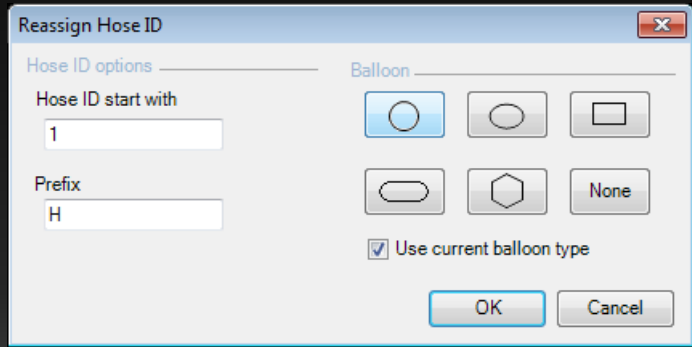

Create a Hose List for selected hoses in the drawing

HOSE ID	QTY	DESCRIPTION
H1	2	HOSE- SAE100 R12 3/4 X 36
H2	1	HOSE SAE 100 R 12 1 1/4 X 72
H3	1	HOSE SAE100 R12 3/4 X 48

Use Component as Accessory

Select Accessories from Library

Accessories Components

Component type
All Component Types

Model Code
Manufacturer
All Manufacturers

Define more criteria

None ...
None ...
None ...

Search

Available accessories

Model Code	Manufacturer	Description
CBEALHV	Sun Hydraulics	Counterbalance Valve
CBGA LAN	Sun Hydraulics	Counterbalance Valve
CGH-10-F-V-30	Eaton	Pilot Operated Relief Valve
CKCBXCN	Sun Hydraulics	Pilot to Open Check Valve
CMV1 B	HAWE	Relief Valve - Screw-in Cartridge
CMV1 C	HAWE	Relief Valve - Screw-in Cartridge
CMV1 E	HAWE	Relief Valve - Screw-in Cartridge

Add

Selected accessories

Model Code	Manufacturer	Description	Quantity
CBGA LAN	Sun Hydraulics	Counterbalance Valve	1

Remove

OK Cancel

Add a Component as an Accessory in the HyDraw Property Manager

ERP Integration

ERP integrated with the HyDraw Ribbon Menu and its settings in HyDraw Options

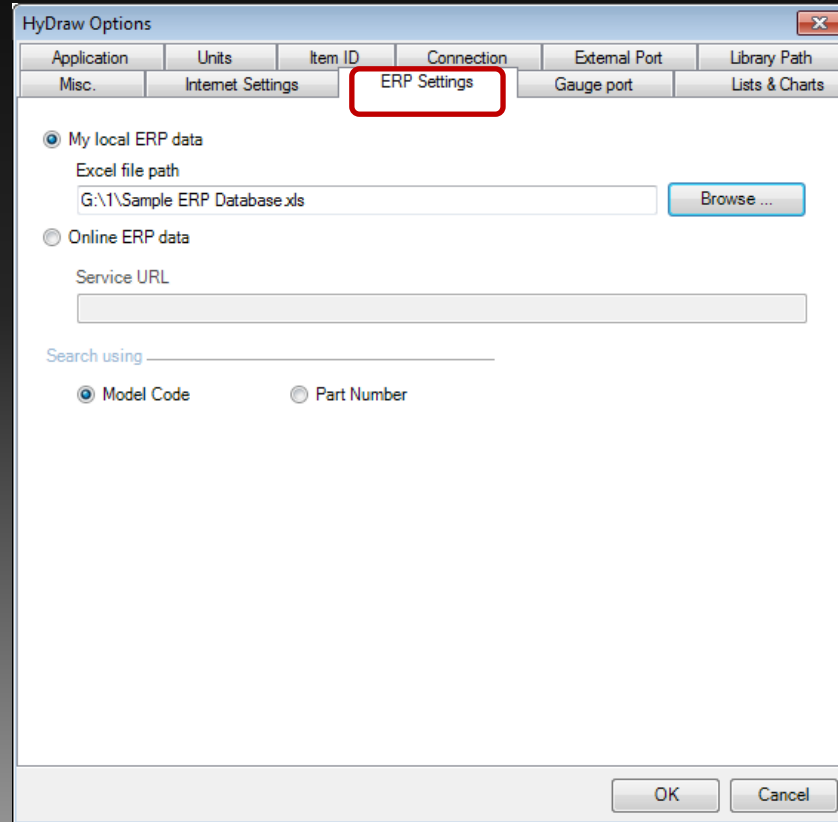
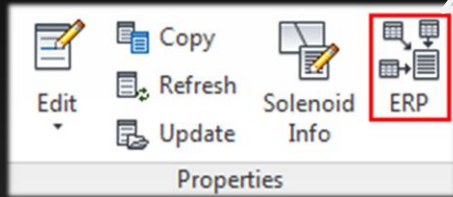

NET Pressure in Net List

Enter Net Pressure for intelligent Port/SAE Flange sizing inside MDTools®*

Create Net List

NET NAME	NET LIST	NET PRESSURE (PSI)	Status
NET-1	MC, C, 4-2	3000	✓
NET-2	T, 1A-2, 3-T	6000	✓
NET-3	MP, P2, P1, 1A-1, 3-P	6000	✓
NET-4	MR, R, 1B-1, 2-2	3000	✓
NET-6	4-1, 3-B	3000	✓
NET-7	1B-2, 2-1, 3-A	6000	✓

Buttons: Recreate, Export, Clear Error Flags, Insert, OK, Cancel

*Upcoming Release of MDTools

Restructured HyDraw Options

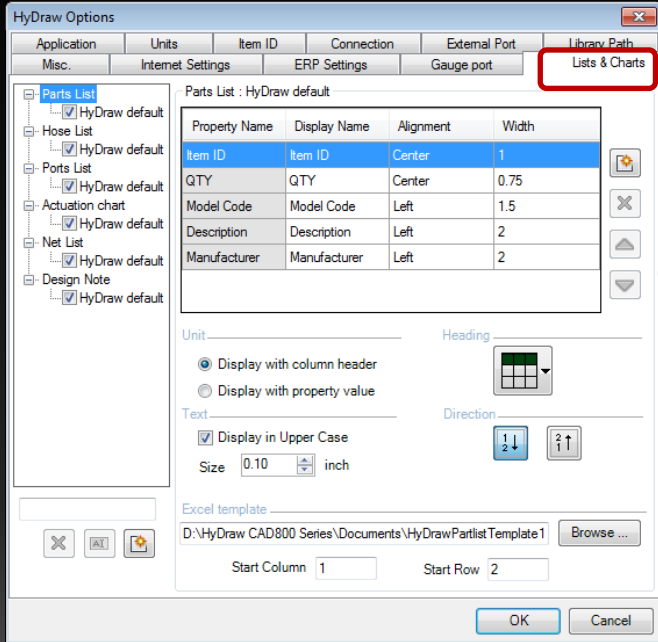

Options

Configure HyDraw preferences.

New Lists & Charts Options

New External Port symbol selection

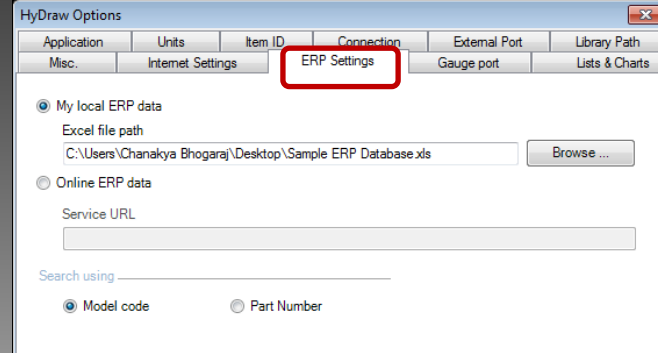
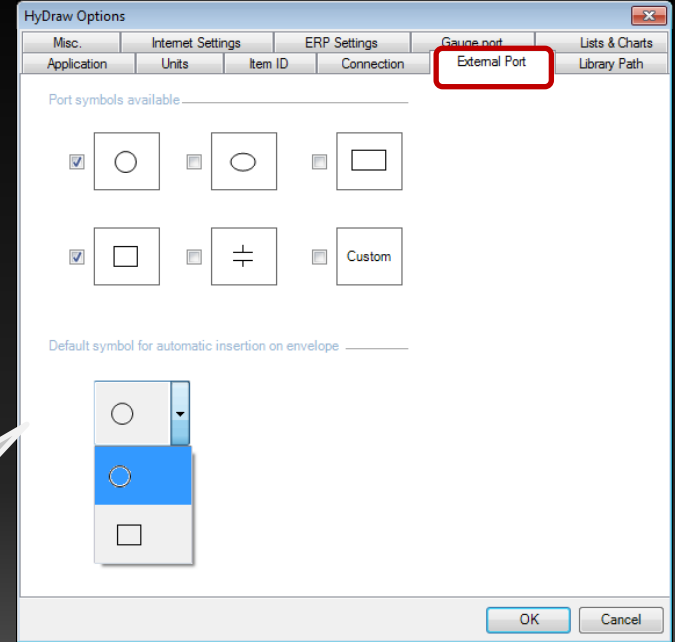

ERP Settings

Item ID and Hose ID Numbering Scheme

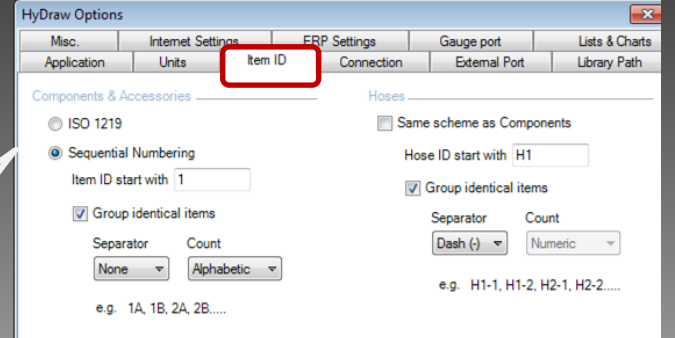

New Hose ID Numbering Scheme

HyDraw Options

Misc. | Internet Settings | ERP Settings | Gauge port | Lists & Charts
Application | Units | Item ID | Connection | External Port | Library Path

Components & Accessories

ISO 1219
 Sequential Numbering
Item ID start with
 Group identical items
Separator: Count:
e.g. 1A, 1B, 2A, 2B.....

Accessory Item ID

Display in drawing
 As sub item of component
Separator: AccessoryID:
 List component as first sub-item

Hoses

Same scheme as Components
Hose ID start with
 Group identical items
Separator: Count:
e.g. H1A, H1B, H2A, H2B.....

Balloon Type

No balloons on external ports

OK Cancel

Hose ID Numbering Scheme

Search by Part Number

Search for a
Symbol/Model
by **Part Number**

HyDraw Library Explorer

Search From Library

Components Sub-systems

Application: Hydraulic

Search using

My local database FluidPowerTools.com | Data Access Settings ▾

Search criteria

Model code Part Number

Manufacturer: All Manufacturers

Component type: Flow Control Valve - Screw-in Cartridge

Part Number: 04

Define more criteria

None ...

None ...

None ...

Clear

Enter model code.

HyDraw Library Explorer

Search From Library

Search result

Part Number	Manufacturer	Description
04.04.02-40-85-40	Bosch Rexroth	Priority Flow Control ...

Right click for more options
<< (1 of 1) >>

Symbols

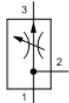

Double click or drag and drop symbol to insert.

Migrate Settings

HyDraw CAD⁷⁰⁰

Migrate HyDraw Settings

HyDraw CAD⁸⁰⁰

HyDraw Options dialog box for HyDraw CAD⁷⁰⁰. The 'Parts List' tab is selected and highlighted with a red box. The 'Configure columns' table is visible.

Property Name	Display Name	Alignment	Width
Item ID	Item ID	Left	1
Description	Description	Left	1.43
Port Size	Port Size	Left	1.17

HyDraw Options dialog box for HyDraw CAD⁷⁰⁰. The 'Parts List' tab is selected and highlighted with a red box. The 'Configure columns' table is visible.

Property Name	Display Name	Alignment	Width
Item ID	Item ID	Left	1
Quantity	Quantity	Left	1
Manufacturer	Manufacturer	Left	1.56
Model Code	Model Code	Left	1.3
Part Number	Part Number	Left	1.43

HyDraw Options dialog box for HyDraw CAD⁸⁰⁰. The 'Parts List' tab is selected and highlighted with a red box. The 'Parts List : VEST Customer' table is visible.

Property Name	Display Name	Alignment	Width
Item ID	Item ID	Left	1
Description	Description	Left	1.43
Port Size	Port Size	Left	1.17

Unit: _____ Heading:

Display with column header
 Display with property value

Text: Display in Upper Case
Size: 0.10 inch

Direction:

VEST Customer

OK Cancel

Migrate HyDraw CAD⁷⁰⁰
Settings into HyDraw
CAD⁸⁰⁰ Settings

Import & Export HyDraw Settings

 Import HyDraw Settings

Import HyDraw Settings from another installation of HyDraw CAD⁸⁰⁰

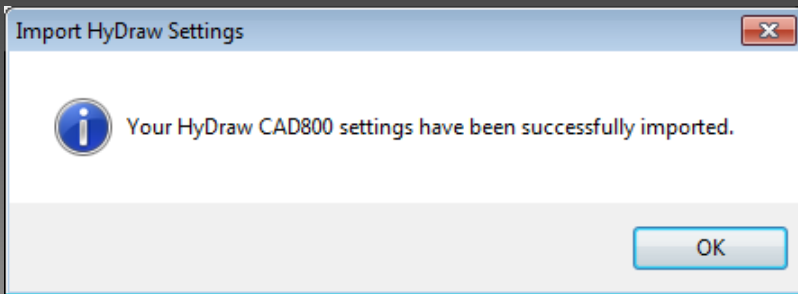
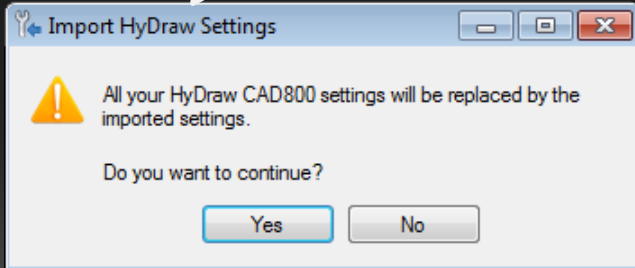

 Export HyDraw Settings

Export HyDraw Settings from HyDraw CAD⁸⁰⁰ to a zip file

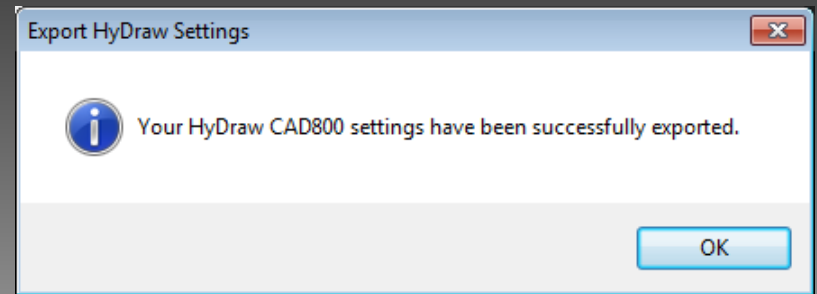
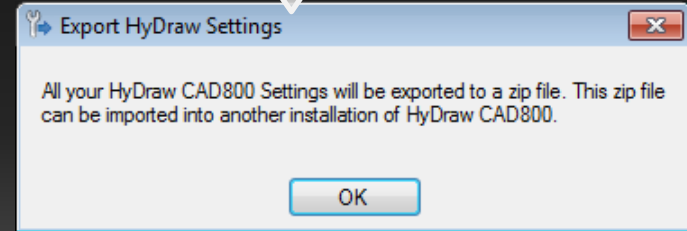

Library Manager 2015

ERP Interface Manager

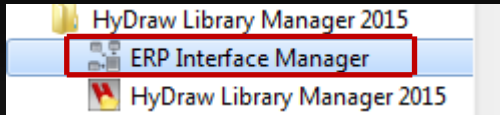

Create the ERP Configuration XML file -
Import data from ERP Excel spreadsheet

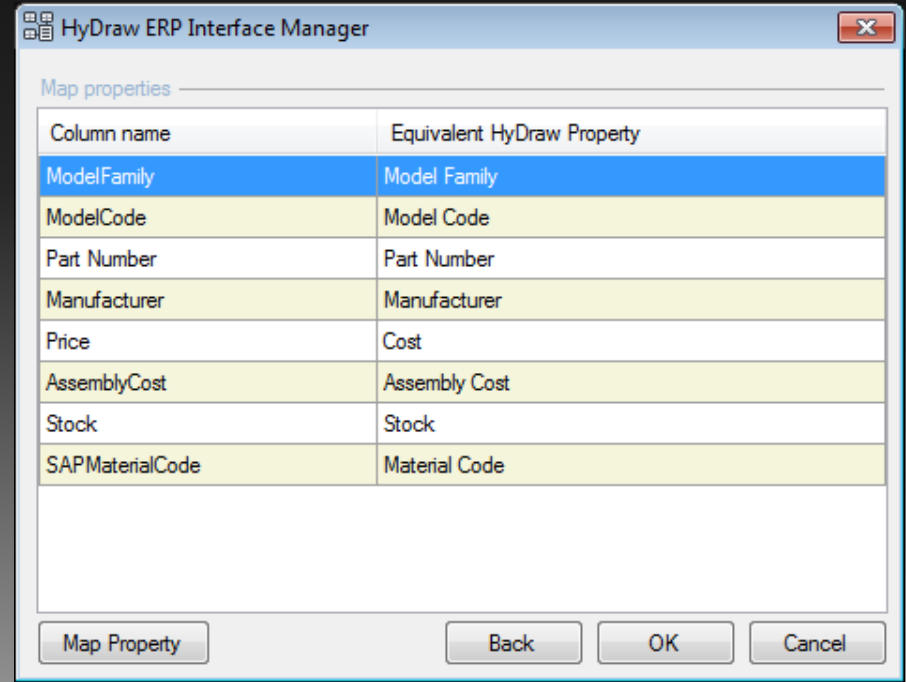
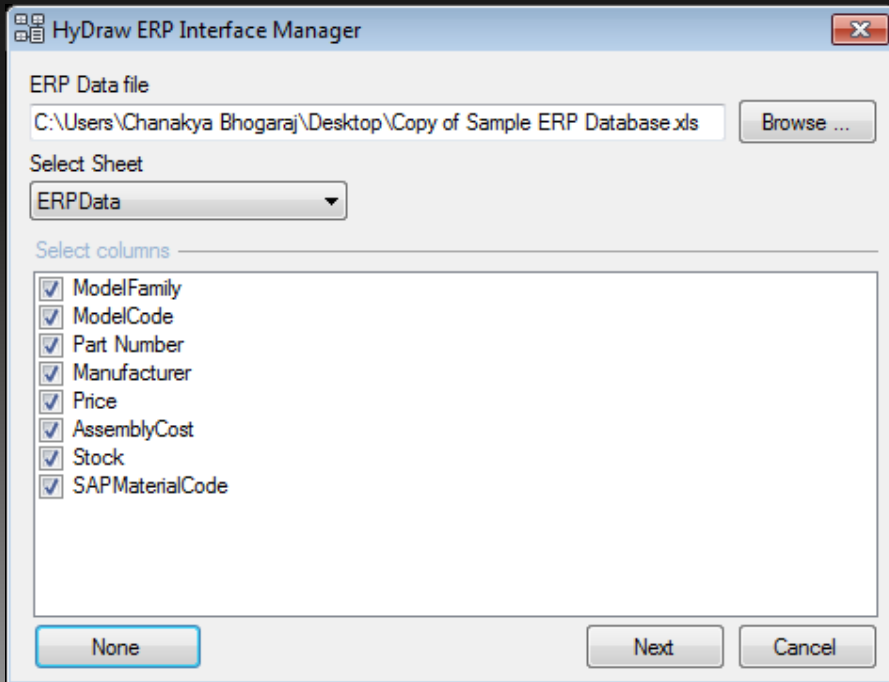

Use Component as Accessory

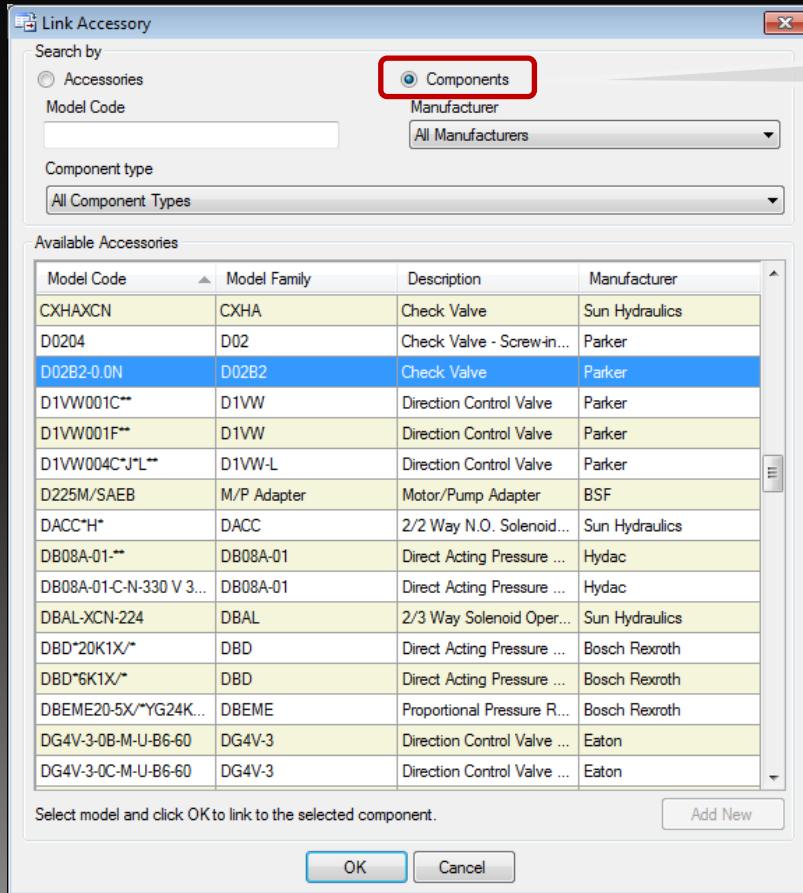

Add a Component as an Accessory in the HyDraw Library Manager

Enhance your productivity and competitive edge with HyDraw®

FREE

HyDraw® CAD⁸⁰⁰ Evaluation Software

Call: +1 (248) 649 9550

Email: sales@VESTusa.com

Visit: www.VESTusa.com

